

Data Sheet



Article number: 203180M16175B3W

Description: E+G levelling foot
GN 31-80-M16-175-B3-W

Note: W With adjustable sleeve , Hygienic Version, Wrench flat at the bottom

Measures

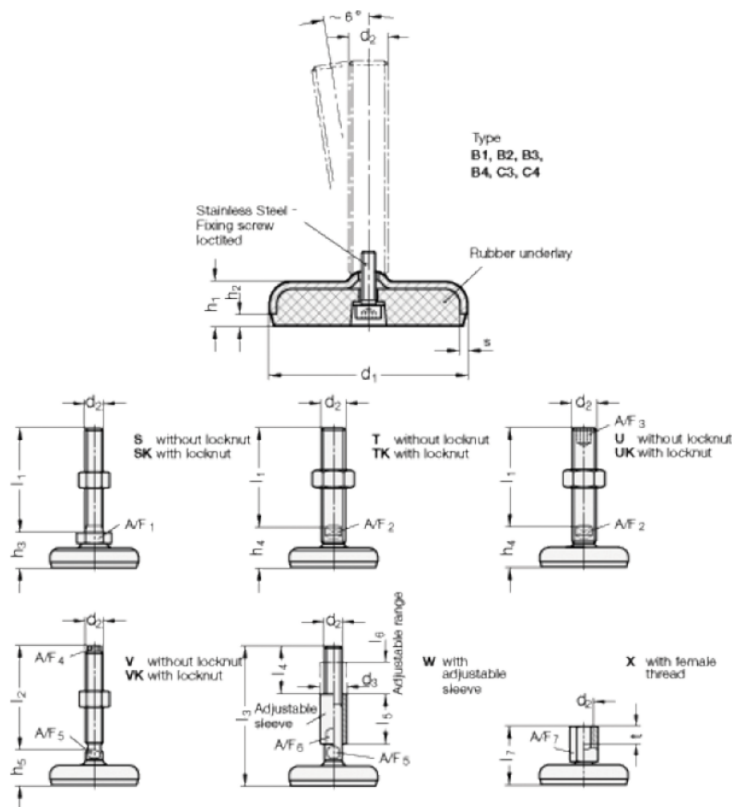

A/F5 = 12	l3 +4.0/0 = 175
A/F6 = 20	l4 = 45
d1 = 80	l5 = 45
d2 = 16	l6 = 29
d3 = 24	s = 3
h1 = 18	
h2 = 5	
l1 = 175	